



Electric deck oven for pizza

2 decks composition

iDeck consists of one or two baking chambers and an optional proofer or stand. The oven's baking surface is made of refractory material, providing the perfect heat distribution over the whole surface. This oven is particularly suitable for direct or indirect pizza baking. Temperature adjustment is electro-mechanical, with independent control of the ceiling and floor heating elements. The oven door is hinged at the bottom, with a tempered glass window to check the product during baking. The stand consists of a painted metal structure, while the proofer is a stainless steel cabinet equipped with a heating thermostat. The proofer can reach the maximum temperature of 65°C(149°F), whereas the maximum temperature of the baking chamber is 450°C (842°F).



FUNCTIONING

- Heating by armoured heating elements
- Separate heating element control by mean contactors that are controlled by thermostats
- Maximum temperature reached 450°C
- Continuous measurement of temperature by probe indicator

CONSTRUCTION

- Front structure made in folded stainless steel
- Oven panels made pre-painted metal sheets
- Door in stainless steel with shutter with hinge at bottom with balancing spring
- Door handle in stainless steel
- Tempered crystal glass
- Control panel on the right front side
- Baking surface in refractory brick
- Upper and lateral structure in aluminized sheet
- Thermal insulation in mineral wool

BAKING ELEMENT INTERNAL DIMENSIONS

Internal height	140 mm
Internal depth	1056 mm
Internal width	660 mm
Baking surface	0,7 m ²

STANDARD EQUIPMENT

- Illumination by halogen lamp
- Independent maximum temperature safety device (only electronic version)

ACCESSORIES

- Proofer on wheels height 1000 mm
- Stand height 600, 900 mm
- 4 wheels kit
- Additional trayholder slides
- Stacking kit
- Hood

TOP VIEW

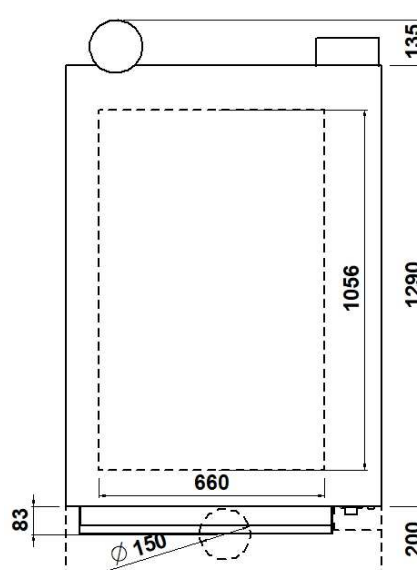

PM 65.105

(assembled with stand height 900mm)

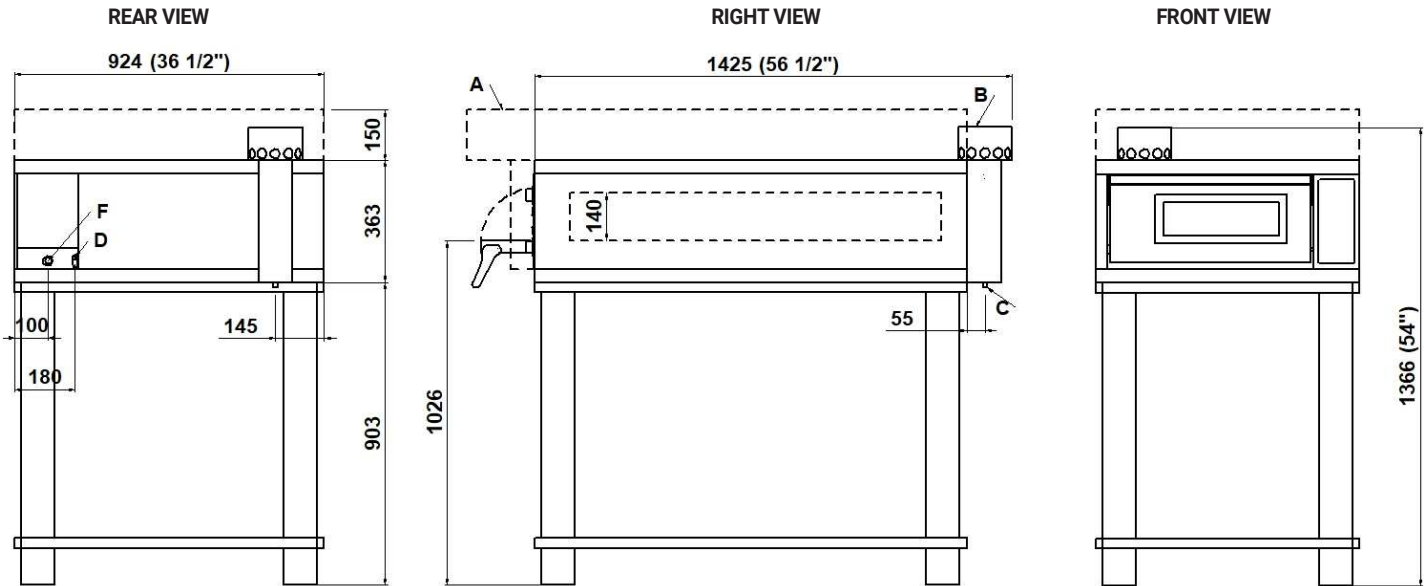

NOTE: The dimensions indicated in the views are in millimeters.

A Ø150 hood steam collector	B Ø INT. 157 steam exhaust	C Ø12 condensate exhaust	D M6 equipotential screw
F fairleads			

EXTERNAL DIMENSIONS

External height	463 mm
External depth	1425 mm
External width	924 mm
Weight	118 kg

SHIPPING INFORMATION

Packed oven sizes:

Height	550 mm
Depth	1500 mm
Width	1110 mm
Weight	(118+21) kg

FEEDING AND POWER

Standard feeding
A.C. V400 3N
Feeding on request
A.C. V230 3

Frequency	50/60 Hz
Max power	7,7 kW
*Average power cons	3,8 kWh

Connecting cable
type H07RN-F
5x4mm² (V400 3N)
4x6mm² (V230 3)

Prover power supply (optional)
A.C. V230 1N 50/60 Hz

Max power	1,5 kW
*Average power cons	0,8 kWh

Conn. cable type H07RN-F 3x1,5mm²

TOTAL BAKING CAPACITY

Tray (600x400)mm	2
Pizza diameter 300mm	6
Pizza diameter 450mm	2

* This value is subject to variation according to the way in which the equipment is used
NOTE: MORETTI FORNI S.P.A. reserves the right to modify the characteristics of the products illustrated in this publication without prior notice

PD 65.105

(assembled with stand height 900mm)

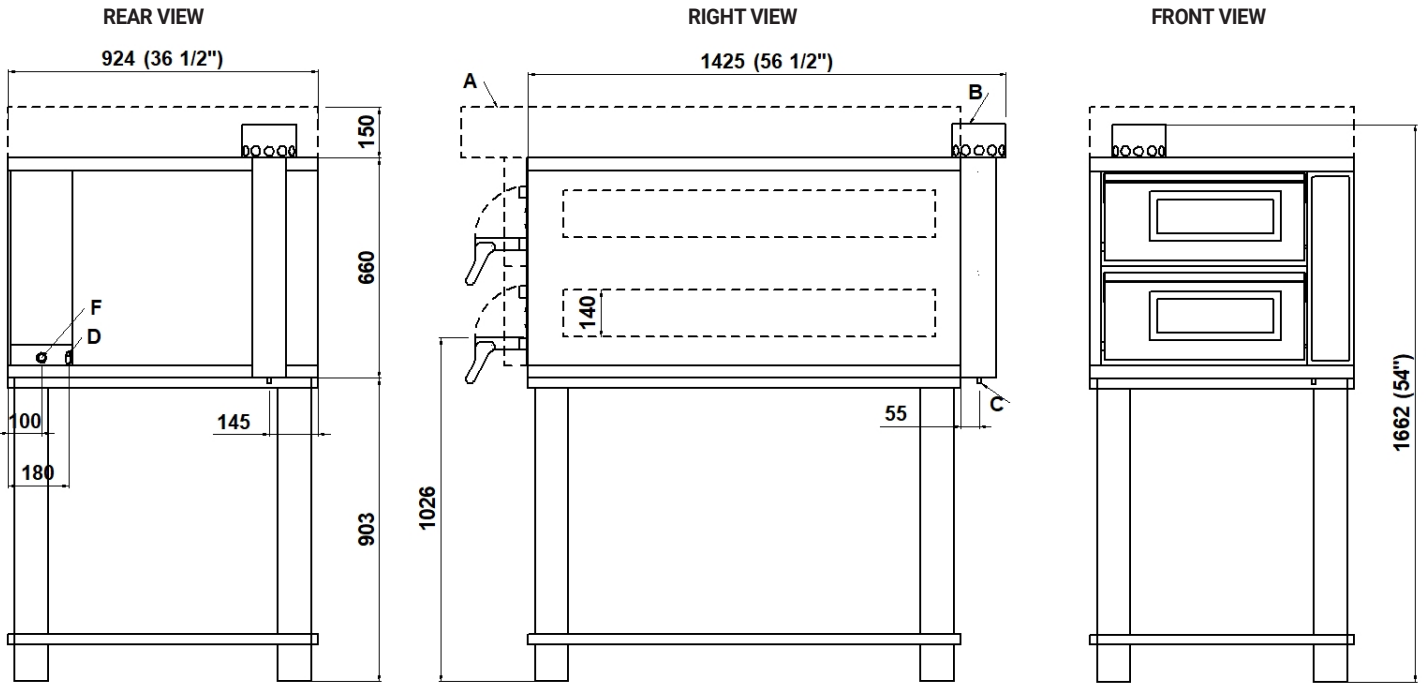

NOTE: The dimensions indicated in the views are in millimeters.

A Ø150 hood steam collector	B Ø INT. 157 steam exhaust	C Ø12 condensate exhaust	D M6 equipotential screw
F fairleads			

EXTERNAL DIMENSIONS

External height	760 mm
External depth	1425 mm
External width	924 mm
Weight	208 kg

SHIPPING INFORMATION

Packed oven sizes:

Max height	870 mm
Max depth	1500 mm
Max width	1110 mm
Weight	(208+23) kg

FEEDING AND POWER

Standard power supply	A.C. V400 3N
Optional power supply	A.C. V230 3
Frequency	50/60 Hz
Max power	15,4 kW
*Average power cons	7,7 kWh
Connecting cable	type H07RN-F
	5x6mm ² (V400 3N)
	4x10mm ² (V230 3)
Prover power supply (optional)	A.C. V230 1N 50/60 Hz
Max power	1,5 kW
*Average power cons	0,8 kWh
Conn. cable type	H07RN-F 3x1,5mm ²

TOTAL BAKING CAPACITY

Tray (600x400)mm	4
Pizza diameter 300mm	12
Pizza diameter 450mm	4

* This value is subject to variation according to the way in which the equipment is used

NOTE: MORETTI FORNI S.P.A. reserves the right to modify the characteristics of the products illustrated in this publication without prior notice