

# CF4-68GEM

60 MAGICLOTUS

GAS COOKERS WITH ELECTRIC OVEN

Combined range static oven - N. 4 burners  
Static oven with grill cm. 64x42x35h, temp:  
50÷250°C, with 1 grid cm.53x32,5 GN1/1 -  
Stainless steel door



Construction - Fabricated using CrNi 18/10 AISI 304 grade Stainless Steel Scotch-Brite Satin polish Finish, incorporating 1mm thick worktop, rounded edges, chromed details and rear splash back. Knobs with waterproof grades IPX5. Model - Professional Gas Cooker with static or multifunction electric oven, with or without side compartment. Burners with electric ignition (CF2/ CF3 with pilot light ignition) and thermocouple safety valves. Modulating flame burners, grills in cast iron, removable liquid collectors. Electric oven with 50 - 300degC control. Maintenance - All serviceable parts are accessible by the easy removal of front control panel and liquid collectors. Fittings - Appliance is supplied with both LPG and Natural Gas conversion jets and adjustable feet.

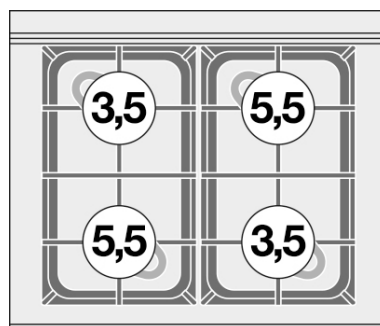

ITALIAN CULINARY ART

The pictures are purely representative. The manufacturer reserves the right to modify the technical data and models without previous notice.

# CF4-68GEM

60 MAGICLOTUS

GAS COOKERS WITH ELECTRIC OVEN

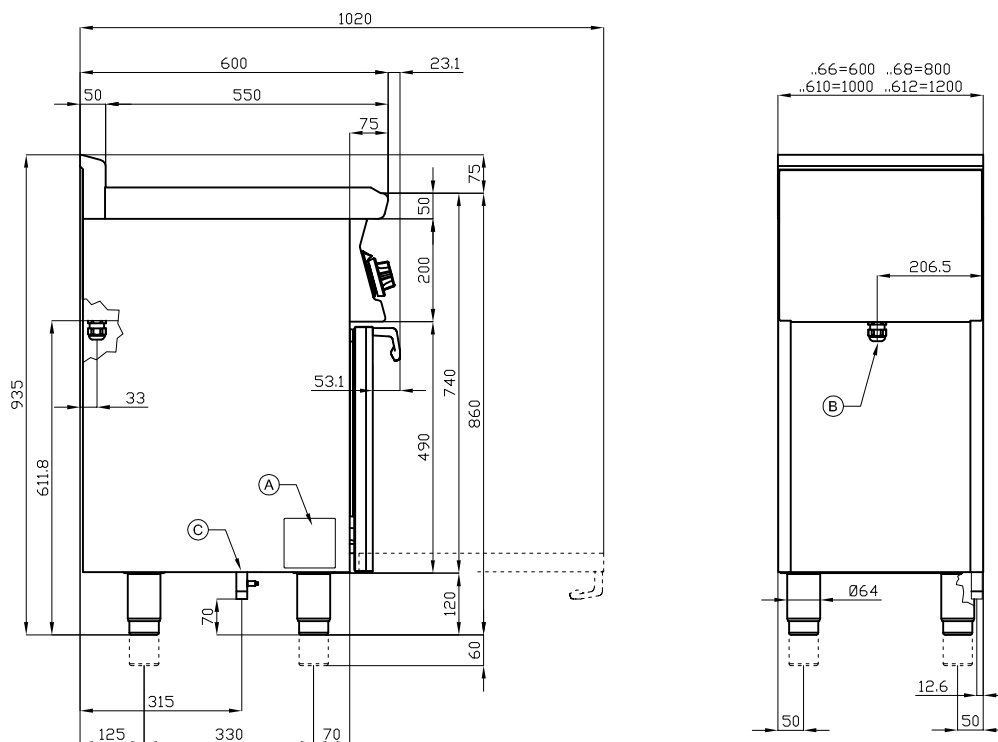

A	Data plate		B	Electrical connection	
C	Gas connection	ISO 7-1 1/2" M			

**MODEL:** CF4-68GEM  
**DIMENSIONS:** cm. 80x 60x 90h  
**GAS POWER:** 18 kW / 15.480 kcal/h  
**GAS TYPE:** Natural Gas / LPG  
**ELECTRIC POWER:** 2,62 kW  
**VOLTAGE:** 230V~  
**FREQUENCY:** 50/60 Hz



**kg:** 97  
**m<sup>3</sup>:** 0.617  
**mm:** 830x670x1110

BUY LOTUS BUY ITALY

The pictures are purely representative. The manufacturer reserves the right to modify the technical data and models without previous notice.



LOTUS S.P.A. Via Calmaor, 46  
 31020 San Vendemiano(TV) - Italy  
 Tel. + 39 0438 778020 / 778468  
 Fax + 39 0438 778277  
 www.lotuscookers.it - lotus@lotuscookers.it