



STRATOS

Gelato and pastry display cabinet



ISA

your visible value



STRATOS

Gelato and pastry display cabinet

STRATOS

Stratos is the new ISA high-end display cabinet that combines maximum technical performance with aesthetics that fully reflect the elegance and unmistakable style of Italian design.

Stratos can be set up with three different types of ventilation:

- **PLUS** single evaporator with double front air out flow.
- **PLUS 1** double evaporator with single air out rear flow.
- **PLUS 2** double evaporator with double air out rear flow.

Stratos has front glass and side glass windows with heated chamber and a heatable laminated upper glass with servo assisted manual opening.

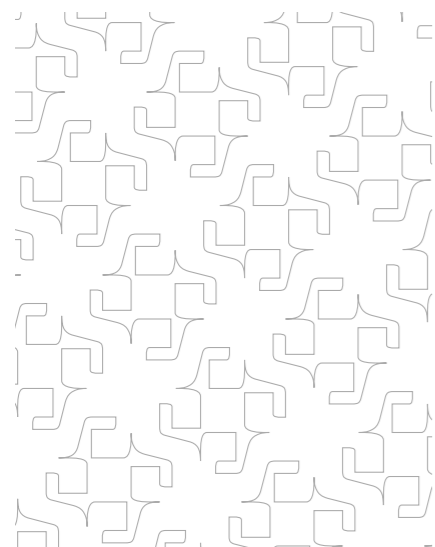



PLUS



PLUS 1



PLUS 2

Three types of ventilation.
Discover them on page 12.

Tre tipologie di ventilazione
Scoprite a pagina 12.

Adjustable deflectors for
lower energy consumption
(Plus1 - Plus2 only)

Deflettori regolabili per un
minore consumo energetico
(solo Plus1 e Plus2)

Excellent gelato
visibility.

Eccellente visibilità
del gelato.



STRATOS

IT

STRATOS è la nuova vetrina di alta gamma ISA che combina il massimo delle prestazioni tecniche ad un'estetica che rispecchia in pieno l'eleganza e lo stile inconfondibile del design italiano.

STRATOS può essere configurata in tre diversi tipi di ventilazione:

- **PLUS** singolo evaporatore a doppia mandata d'aria a flusso anteriore.
- **PLUS 1** doppio evaporatore a singola mandata d'aria a flusso posteriore.
- **PLUS 2** con doppio evaporatore a doppia mandata d'aria e flusso posteriore.

STRATOS ha il vetro frontale e vetri laterali in vetro camera riscaldato, vetro superiore stratificato riscaldabile con apertura manuale verso l'alto servoassistita.

FR

Stratos est la nouvelle vitrine haute gamme ISA qui unit le maximum des prestations techniques à une esthétique qui reflète pleinement l'élégance et le style unique du design italien.

Stratos peut être configurée en trois différents types de ventilation;

- **PLUS**: un seul évaporateur à double refoulement d'air à flux antérieur.
- **PLUS 1**: deux évaporateurs à simple refoulement d'air à flux postérieur.
- **PLUS 2**: deux évaporateurs à double refoulement d'air et flux postérieur.

Stratos a la vitre avant et celles latérales en double vitrage chauffant, la vitre supérieure stratifiée avec dégivrage et ouverture manuelle servoassistée vers le haut.

DE

Stratos ist die neue Top-Theke von ISA, welche das Maximum der technischen Leistungen mit einer Ästhetik kombiniert, welche die Eleganz und dem unverwechselbaren Stil des italienischen Designs widerspiegelt.

Stratos kann in drei unterschiedlichen Ventilationstypen konfiguriert werden:

- **PLUS** einzelner Verdampfer mit doppelter Zuluft mit Luftstrom vorne.
- **PLUS 1** doppelter Verdampfer mit einzelner Zuluft mit Luftstrom hinten.
- **PLUS 2** mit doppeltem Verdampfer mit doppelter Zuluft mit Luftstrom hinten.

Stratos hat eine Frontscheibe und seitliche Scheiben mit geheizter Doppelverglasung und die obere Scheibe ist aus heizbarem Verbundverglasungsglas mit servobetätigter manueller Öffnung nach oben.

ES

Stratos es el nuevo mostrador de alta gama ISA que combina rendimientos máximos con una estética que refleja totalmente la elegancia y el estilo inconfundible del diseño italiano.

Stratos se puede configurar en tres distintos tipos de ventilación:

- **PLUS** evaporador individual de doble salida de aire con flujo frontal.
- **PLUS 1** evaporador doble de salida individual de aire con flujo posterior.
- **PLUS 2** con doble evaporador de dos salidas de aire y flujo posterior.

Stratos tiene el cristal frontal y los cristales laterales de vidrio cámara calentado, vidrio superior estratificado que se puede calentar con abertura manual hacia arriba servoasistida.

GELATO

STRATOS



STRATOS

H 125
P 120
L 120 • 170 • 220 • 120+50 • 170+50

Gelato

Installation

- Plug-in
- Remote (optional)

Configuration

- Canalized (optional)
- Dual Temperature (optional)

Temperature

-20/+2 °C

Refrigerant

R404A

Refrigeration

- Ventilated
- Plus
- Plus 1 (optional)
- Plus 2 (optional)

Compressor

Hermetic

Defrost

Reverse cycle

Climate class

- 7 - Plus
- 4 - Plus 1 / Plus 2

Upper glass

Heated stratified with switch

Front glass

Heated double

Side glasses

Heated double

Opening system

Servo, bottom-up opening system

Rear closing system

- Plexiglass Sliding doors
- Self rolling curtain

Work top

Solid surface White

Lightning

Led 5700 K°

Equipment handling

Swivel casters with brake and height adjustable feet

Installazione

- Plug-in
- Remoto (optional)

Configurazione

- Canalizzabile (optional)
- Dual Temperature (optional)

Temperatura

-20/+2 °C

Refrigerante

R404A

Refrigerazione

- Ventilata
- Plus
- Plus 1 (optional)
- Plus 2 (optional)

Compressore

Ermetico

Sbrinamento

Inversione di ciclo

Classe Climatica

- 7 - Plus
- 4 - Plus 1 / Plus 2

Vetro superiore

Stratificato riscaldato (disattivabile)

Vetro frontale

Doppio (camera) riscaldato

Vetri laterali

Doppi (camera) riscaldati

Apertura anteriore

Apertura servoassistita verso l'alto

Chiusura posteriore

- Scorrevoli in Plexiglass
- Tenda manuale autoavvolgente

Piano di servizio

Superficie solida bianca

Illuminazione

Led 5700 K°

Movimentazione

Ruote pivotanti con freno e piedini regolabili in altezza

Opening system

Servo, bottom-up opening system

Apertura anteriore

Apertura servoassistita verso l'alto

Front glass

Heated double

Vetro frontale

Doppio (Camera) riscaldato

Upper glass

Heated stratified with switch

Vetro superiore

Stratificato riscaldato (disattivabile)

Side glasses

Heated double

Vetri laterali

Doppi (Camera) riscaldati



Dual Temperature

Designed with maximum flexibility to allow seasonal product display management. The Dual Temperature function (optional) allows the display cabinet to change simply, the operating temperature for Ice Cream and Pastry Products. This allows one cabinet to offer seasonal flexibility without increasing floor space.

Massima flessibilità e perfetta gestione dei cicli stagionali. La funzione Dual Temperature (optional) permette alla vetrina di passare con estrema semplicità da Gelateria a Pasticceria, e viceversa, permettendovi di avere un locale multifunzionale con un unico prodotto: possibilità di variare stagionalmente l'offerta e il layout del vostro spazio.

Plus.

Total control of cold performances



PLUS

Évaporateur simple avec refoulement de l'air à flux avant double.

Single evaporator with double front air out flow.

Einzelner Verdampfer mit doppelter Luftzuleitung mit vorderem Luftstrom.

Singolo evaporatore con doppia mandata d'aria a flusso anteriore.

Evaporador sencillo con doble línea de impulsión de aire de flujo anterior.

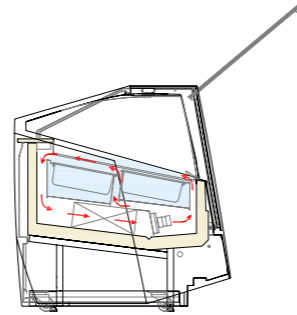

PLUS 1

Évaporateur double avec refoulement de l'air à flux arrière simple.

Double evaporator with single air out rear flow.

Doppelter Verdampfer mit einzelner Luftzuleitung mit hinterem Luftstrom.

Doppio evaporatore con singola mandata d'aria a flusso posteriore.

Evaporador doble con una sola línea de impulsión de aire de flujo posterior.

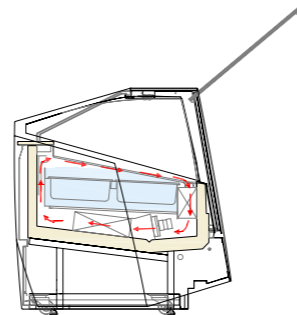

PLUS 2

Évaporateur double avec refoulement de l'air à flux arrière double.

Double evaporator with double air out rear flow.

Doppelter Verdampfer mit doppelter Luftzuleitung mit hinterem Luftstrom.

Doppio evaporatore con doppia mandata d'aria a flusso posteriore.

Evaporador doble con con doble línea de impulsión de aire de flujo posterior.

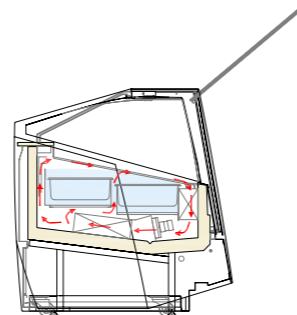

PLUS



PLUS 1



PLUS 2





Gelato Style	Gelato	PLUS	PLUS 1	PLUS 2
"High" Gelato Gelato "Alto"	-	-	• recommended / consigliato	•
Ice cream sticks Stecchi	•	•	•	•
Single portions Monoporzioni	•	•	•	•
Frozen pastry Pasticceria fredda	•	•	•	•
Performance	Evaporators Evaporatori	1	2	2
	Air outlet Mandata d'aria	2	1	2
	Inclination of the display Inclinazione del piano espositivo	11°	3°	0°
	4 - Climate Class / Classe climatica 30 °C / 55 %RH	-	•	•
	7 - Climate Class / Classe climatica 35 °C / 75 %RH	•		
	Air out deflectors / Deflettori uscita aria	Fixed Fissi	Adjustable Regolabili	Adjustable Regolabili
Setup Allestimento	Container / Vaschetta 5 Lt. 360x165x120h	•	•	•
	Container / Vaschetta 7 Lt. 360x165x150h	-	-	-
	Container / Vaschetta 5 Lt. 360x250x80h	•	•	•
	Container / Vaschetta 10 Lt. 360x250x120h	•	•	•
	Container / Vaschetta 12 Lt. 360x250x150h	-	-	-
	Ice cream stick container / Stecchi vaschetta 360x250x43h	•	•	•
	Single portions container / Vaschetta monoporzioni 360x250x43h	•	•	•
	Pastry trays Vassoio pasticceria	Separate / Separati —	Single / Unico —	Separate / Separati —

	120	170	220	120+50	170+50
External dimensions (LxDxH) Dimensioni esterne (LxPxH)	1190x1200x1254 mm	1685x1200x1254 mm	2180x1200x1254 mm	1685x1200x1254 mm	2180x1200x1254 mm
Capacity (gross/net) Capacità (lorda/netta)	719 / 147 lt	1059 / 216 lt	1399 / 285 lt	1059 / 216 lt	1399 / 285 lt
Net weight Peso netto	400 kg	460 kg	510 kg	460 kg	510 kg
Refrigeration Refrigerazione	Ventilated Ventilata				
Refrigerant Refrigerante	R404A				
Climate class Classe climatica	4 (Plus 1 / Plus 2)		7 (Plus)		
Operating conditions Condizioni ambientali	30 °C / 55 %RH (Plus 1 / Plus 2)		35 °C / 75 %RH (Plus)		
Cabinet capacity range Temperatura di regolazione	-20/+2 °C		-20/+2 °C Dual Zone		
Product temperature Temperatura prodotto	-16/-14 °C		-16/-14 °C Dual Zone		
Compressor (type) Compressore (tipologia)	1 Hermetic 1 Ermetico	2 Hermetics 2 Ermetici			
Defrost Sbrinamento	Reverse Cycle Inversione di Ciclo				
Power supply Alimentazione	230 V / 1 Ph / 50 Hz		400 V / 3 Ph / 50 Hz		
Electrical input (nominal) Assorbimento elettrico (regime)	1240 W / 6 A	1720 W / 3 A	2700 W / 4,2 A	1720 W / 3 A	2700 W / 4,2 A
Electrical input (defrost) Assorbimento elettrico (sbrinamento)	2300 W / 11 A	2950 W / 4,9 A	6300 W / 8,5 A	2950 W / 4,9 A	6300 W / 8,5 A

Technical sheet about models with condensing unit included with air cooled
Dati tecnici riferiti a modelli con unità a bordo con condensazione ad aria

Setup

Allestimento

5 Lt 360 x 165 x 120 h		12	18	24	18 (6+12)	24 (6+18)
5 Lt 360 x 250 x 80 h		8	12	16	12 (4+8)	16 (4+12)
10 Lt 360 x 250 x 120 h		8	12	16	12 (4+8)	16 (4+12)
Ice cream stick container Vaschetta stecchi		8	12	16	12 (4+8)	16 (4+12)
Portions container Vaschetta monoporzioni		8	12	16	12 (4+8)	16 (4+12)
Pastry trays Vassoi pasticceria		•	•	•	•	•
PLUS - PLUS 1 - PLUS 2						

Accessori

Accessories

Grey cone holder Portaconi completo grigio			•			
Cone holder complete of toppings container Portaconi completo di vaschette portagranelle			•			
Console scoop washer with shower Consolle lavaporzionate con doccia			•			
Console scoop washer with water tap Consolle lavaporzionate con rubinetto			•			

H125



Single evaporator with double front air out flow. Fixed deflectors.
Singolo evaporatore con doppia mandata d'aria a flusso anteriore. Deflettori fissi.

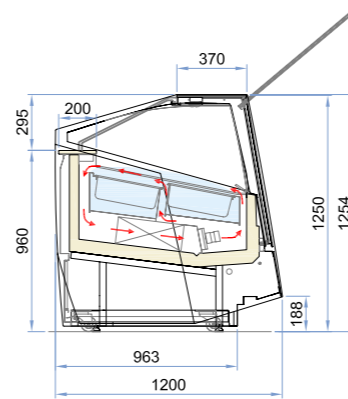



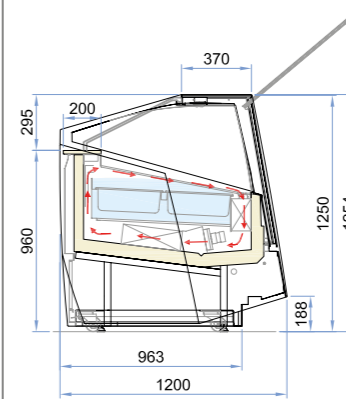

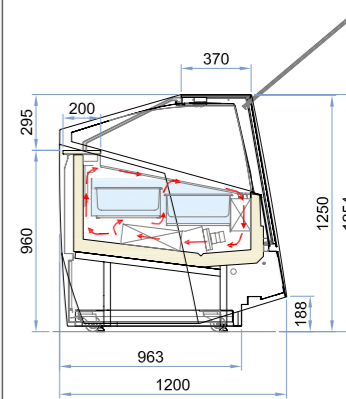

Double evaporator with single air out rear flow. Adjustable deflectors.
Doppio evaporatore con singola mandata d'aria a flusso posteriore. Deflettori regolabili.



Double evaporator with double air out rear flow. Adjustable deflectors.
Doppio evaporatore con doppia mandata d'aria a flusso posteriore. Deflettori regolabili.



Available colours - Colori disponibili

Front panel (1) Pannello frontale	Front panel (2) Pannello frontale	Side panels (3) Fianchi laterali
<ul style="list-style-type: none"> ●  RAL 9005 ●  RAL on demand ● Standard / Di serie 	<ul style="list-style-type: none"> ●  RAL 1013 ●  RAL on demand ● Standard / Di serie 	<ul style="list-style-type: none"> ●  RAL 9005* ●  RAL 1013 ●  RAL on demand ● Standard / Di serie <small>*unchangeable / non modificabile</small>



PASTRY

STRATOS



STRATOS

H 125
P 120
L 120 • 170 • 220

Pastry

Installation

- Plug-in
- Remote (optional)

Configuration

Canalized (optional)

Temperature

+1/+10 °C

Refrigerant

R404A

Refrigeration

Ventilated

Compressor

Hermetic

Defrost

Off cycle

Climate class

3

Upper glass

Heated stratified with switch

Front glass

Heated double

Side glasses

Heated double

Opening system

Servo, bottom-up opening system

Rear closing system

- Plexiglass Sliding doors
- Self rolling curtain

Work top

Solid surface White

Lightning

Led 5700 K°

Equipment handling

Swivel casters with brake and height adjustable feet

Installazione

- Plug-in
- Remoto (optional)

Configurazione

Canalizzabile (optional)

Temperatura

+1/+10 °C

Refrigerante

R404A

Refrigerazione

Ventilata

Compressore

Ermetico

Sbrinamento

Fermata compressore

Classe Climatica

3

Vetro superiore

Stratificato riscaldato (disattivabile)

Vetro frontale

Doppio (camera) riscaldato

Vetri laterali

Doppi (Camera) riscaldati

Apertura anteriore

Apertura servoassistita verso l'alto

Chiusura posteriore

- Scorrevoli in Plexiglass
- Tenda manuale autoavvolgente

Piano di servizio

Superficie solida bianca

Illuminazione

Led 5700 K°

Movimentazione

Ruote pivotanti con freno e piedini regolabili in altezza



Opening system
 Servo, bottom-up opening system

Apertura anteriore
 Apertura servoassistita verso l'alto

Refrigerated shelf

Mensola refrigerata

Front glass
 Heated double

Vetro frontale
 Doppio (Camera) riscaldato

Upper glass
 Heated stratified with switch

Vetro superiore
 Stratificato riscaldato (disattivabile)

Side glasses
 Heated double

Vetri laterali
 Doppi (Camera) riscaldati

	120	170	220
External dimensions (LxDxH) Dimensioni esterne (LxPxH)	1190 x 1200 x 1254 mm	1685 x 1200 x 1254 mm	2180 x 1200 x 1254 mm
Capacity (gross/net) Capacità (lorda/netta)	720 / 240 lt	1059 / 317 lt	1398 / 418 lt
Net weight Peso netto	400 kg	460 kg	510 kg
Refrigeration Refrigerazione		Ventilated Ventilata	
Refrigerant Refrigerante		R404A	
Climate class Classe climatica		3	
Operating conditions Condizioni ambientali		25 °C / 60 %RH	
Product temperature Temperatura prodotto		+1/+10 °C	
Compressor (type) Compressore (tipologia)		1 Hermetic 1 Ermetico	
Defrost Sbrinamento		Off Cycle Fermata compressore	
Power supply Alimentazione		230 V / 1 Ph / 50 Hz	
Electrical input (nominal) Assorbimento elettrico (regime)	1240 W / 6 A	1720 W / 3 A	2700 W / 4,2 A
Electrical input (defrost) Assorbimento elettrico (sbrinamento)	2300 W / 11 A	2950 W / 4,9 A	6300 W / 8,5 A
<small>Technical sheet about models whit condensing unit included with air cooled Dati tecnici riferiti a modelli con unità a bordo con condensazione ad aria</small>			
Setup Allestimento			
Pastry trays Vassoi pasticceria	•	•	•

Available colours - Colori disponibili

H125

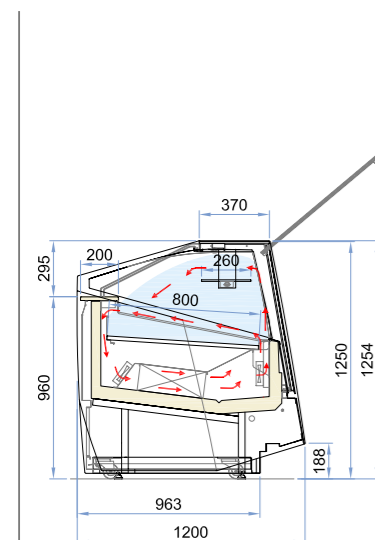

- | | | |
|---|---|---|
| Front panel (1)
Pannello frontale | Front panel (2)
Pannello frontale | Side panels (3)
Fianchi laterali |
| <ul style="list-style-type: none"> ● RAL 9005 ● RAL on demand | <ul style="list-style-type: none"> ● RAL 1013 ● RAL on demand | <ul style="list-style-type: none"> ● RAL 9005* ● RAL 1013 ● RAL on demand |
| <ul style="list-style-type: none"> ● Standard / Di serie | <ul style="list-style-type: none"> ● Standard / Di serie | <ul style="list-style-type: none"> ● Standard / Di serie |

*unchangeable / non modificabile





ISA nasce in Umbria, nel cuore di quell'Italia rinomata in tutto il mondo per la sua eccellenza artigiana, industriale e creativa. Con quattro stabilimenti e la presenza in oltre 100 mercati globali ISA è uno dei player al mondo più importanti del mercato dell'arredamento per locali pubblici, delle vetrine e degli armadi refrigerati per gelateria e pasticceria e dell'arredamento professionale.

ISA was established in Umbria, in the heart of Italy, a nation that is famed all over the world for its artisan, industrial and creative excellence. With four sites and the presence in over 100 global markets, ISA is one of the most important players on furniture market for public places, ice cream display cabinets, pastry display cases and professional furniture.

ISA nait en Ombrie, au milieu de cette partie-là d'Italie célèbre dans tout le monde pour son excellence artisanale, industrielle et créative. Avec quatre usines et en étant sur plus de 100 marchés globaux, ISA est un des joueurs les plus importants sur le marché international de l'ameublement pour locaux publiques, de vitrines et d'armoires d'exposition réfrigérées pour glacerie et pâtisserie et de l'ameublement professionnel.

ISA wurde in Umbrien gegründet, im Herzen Italiens, die in der ganzen Welt für ihre handgefertigte, industrielle und kreative Vorzüglichkeit berühmt ist. Mit vier Werkanlagen und dank der Anwesenheit in mehr als 100 ISA Global Märkten, ist ISA einer der wichtigsten Player der weltweiten Möbelmarkt für Lokale, Vitrinen und Kühlschränke für Eisdiele und Konditorei und professionelle Einrichtung.

ISA nace en Umbria, en el corazón de una Italia de renombre en todo el mundo por su artesanía, industria y creatividad excelentes. Con cuatro establecimientos y presente en más de 100 mercados globales, ISA es uno de los principales protagonistas mundiales del mercado del mobiliario profesional y de locales públicos así como de los expositores y refrigeradores para heladería y pastelería.



La ISA S.p.A. nell'ambito del continuo miglioramento del prodotto, si riserva il diritto di modificare in qualsiasi momento, senza preavviso, le caratteristiche tecniche ed estetiche dei propri modelli.

In the interest of continual product improvements, ISA S.p.A. reserves the right to make changes in technical specifications and accessories at any moment and without prior notice.



ISA S.p.A.

via Madonna di Campagna 123
06083 Bastia Umbra (PG)
Italy

T. +39 075 801 71

F. +39 075 800 09 00

E. customerservice@isaitaly.com

www.isaitaly.com

